

JK48V100PRO Battery Pack

User Manual





Please comply with all warnings and operating instructions in this manual strictly. Save this manual properly and read carefully the following instructions before installing the unit. Do not operate this unit before reading through all safety information and operating instructions carefully.

1.SAFETY PRECAUTION.....	4
1.1 WHEN USING BATTERY.....	4
1.2 WHILE CHARGING.....	5
1.3 WHEN DISCHARGING THE BATTERY.....	5
2.PARAMETERS OF BATTERY.....	6
2.1 BASIC BLOCK DIAGRAM.....	6
2.2 BATTERY SPECIFICATIONS.....	7
2.3 PANEL VIEW.....	8
2.4 GENERAL.....	9
2.4.1 Power & RST Key.....	9
2.4.2 Breaker.....	9
2.4.3 ADS (Address).....	10
2.4.4 DCT(Dry Contacts).....	10
2.4.5 RS485A&CAN (RJ45 Connector).....	11
2.4.6 RS232 (RJ12 Connector).....	11
2.4.7 RS485B&RS485C (RJ45 Connector).....	11
2.4.8 Positive & Negative Terminal.....	12
2.5 BUZZER OPERATION (OPTIONAL).....	12
2.6 LED INDICATORS.....	13
2.7 DISPLAY FUNCTION INSTRUCTION.....	14
2.7.1 Display Rendering.....	14
2.7.2 Functional Specifications.....	14
3. SAFE HANDLING GUIDE.....	17
3.1 SYSTEM DIAGRAM.....	17
3.2 TOOLS.....	17
3.3 SAFETY GEAR.....	17
3.4 INSTALLATION.....	18
3.4.1 Standard Telecom Server Rack Cabinet Install.....	18
3.4.2 Simple Self Rack Mounted.....	20
3.4.3 Battery Parallel Connection.....	21
3.4.4 Other Wire Connection.....	22
3.4.5 Installation Location.....	22
4. SOFTWARE & COMMUNICATION.....	23
4.1 USB-RS232-RJ12 DRIVER INSTALLATION.....	23
4.2 PC SOFTWARE INSTALLATION.....	23
4.3 BMS & INVERTER COMMUNICATION SETUP.....	24
4.3.2 Communicate With PC/Software.....	24
4.3.3 Communicate With Inverter (Optional).....	26

5. TROUBLESHOOTING.....	28
6. STORAGE AND MAINTENANCE.....	29
6.1. STORAGE.....	29
6.2. MAINTENANCE.....	29
7 PRODUCT RESPONSIBILITIES AND CONSULTING.....	30

1.Safety Precaution

1.1 When Using Battery

Danger of High Voltage:

The high voltage power supply offer the equipment power, wet object contact high voltage power supply directly or indirectly , can cause fatal danger.

Using a special tool :

Working in high voltage and ac power, be sure to use a special tool instead of individual tools.

Static-free:

Static electricity would damage veneer on the electrostatic sensitive components, before touching the plug-in, circuit board or chips, be sure to use correct electrostatic prevention measures.

Disconnect the power supply in operation:

When operate the power supply, you must first cut off power supply, power operation is prohibited.

Dc short circuit dangerous:

Power system provides dc regulated power supply. Dc short circuit could cause fatal damage to the e quipment.

1.2 While Charging

CAUTION

The temperature range over which the battery can be charged is 0°C to 45°C. Charging the battery at temperatures outside of this range may cause the battery to become hot or to break. Charging the battery outside of this temperature range may also harm the performance of the battery or reduce the battery's life expectancy.

1.3 When Discharging the Battery

DANGER

Do not discharge the battery using any device except for the specified device. When the battery is used in devices aside from the specified device it may damage the performance of the battery or reduce its life expectancy, and if the device causes an abnormal current to flow, it may cause the battery to become hot and cause serious injury.

CAUTION

The temperature range over which the battery can be discharged is -20°C to 60°C. Use of the battery outside of this temperature range may damage the performance of the battery or may reduce its life expectancy.

2.Parameters of Battery

2.1 Basic Block Diagram

- There are Battery cells and BMS board inside, before connecting the terminal, please read the diagram, and make sure the output is no short or other abnormal connection.

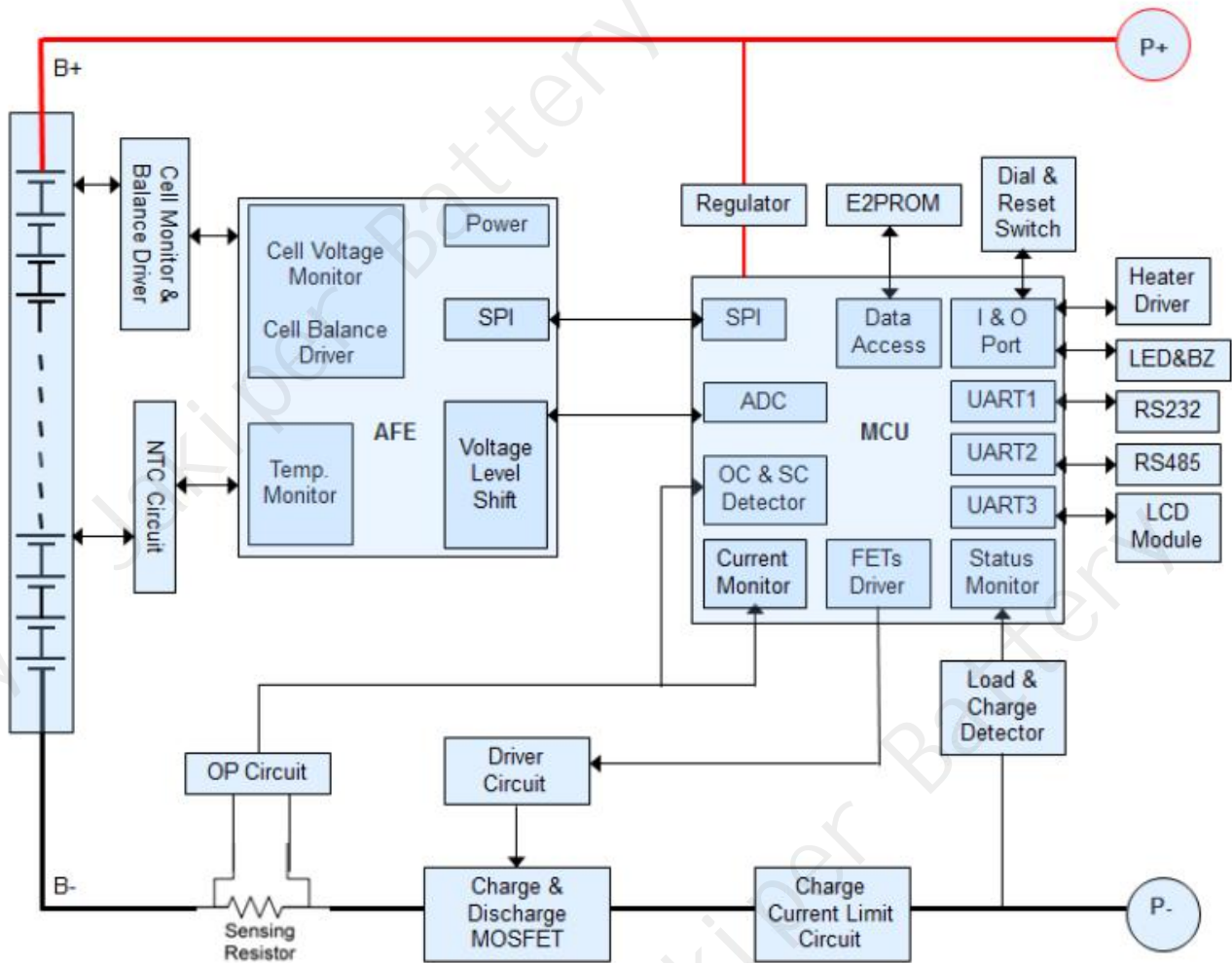

Fig1 Battery Block Diagram

2.2 Battery Specifications

ELECTRICAL PERFORMANCE	
Model	JK48V100PRO
Nominal Voltage	51.2 V
Nominal Capacity	100 Ah
Energy	5120 Wh
Resistance	< 50mΩ
Self Discharge	< 3%
Cells	16 x 3.2V 100Ah Cells

CHARGE PERFORMANCE	
Recommended Charge Current	20 A
Maximum Charge Current	100 A
Recommended Charge Voltage	57.6 V (3.6 V/Cell)
BMS Charge Cut-Off Voltage	> 59.2 V (3.7 V/Cell)
Reconnect Voltage	< 54.08 V (3.38 V/Cell)
Balancing Voltage	> 54.4 V (3.4 V/Cell)

DISCHARGE PERFORMANCE	
Maximum Continuous Discharge Current	100 A
BMS Discharge Current High Warning	125 A
BMS Discharge Cut-Off Current	130 A (1000ms)
Low Voltage Warning	44.8 V (2.8 V/Cell*16)
BMS Discharge Cut-Off Voltage	<40 V (1 s) (2.5 V/Cell*16)
Reconnect Voltage	>46.4 V (2.9 V/Cell)
Short Circuit Protection	300 μs

MECHANICAL PERFORMANCE	
-------------------------------	--

Dimension (LxWxH)	17.4 x 15.7 x 8.7" (442x400x221mm)
Approx. Weight	99 lbs (45 Kg)
Terminal Type	M8x4
Terminal Torque	106 ~ 132 in-lbs (12 ~ 15 N·m)
Case Material	Steel
Recommended Connection Wire	6 AWG

TEMPERATURE PERFORMANCE

Temperature Sensor Quantity	6 pcs
Discharge Temperature	- 4 ~ 140 °F (- 20 ~ 60 °C)
Charge Temperature	23 ~ 131 °F (- 5 ~ 55 °C)
Storage Temperature	23 ~ 95 °F (- 5 ~ 35 °C)
BMS High Temperature Cut-Off	149 °F (65 °C)
Reconnect Temperature	140 °F (60 °C)

2.3 Panel View

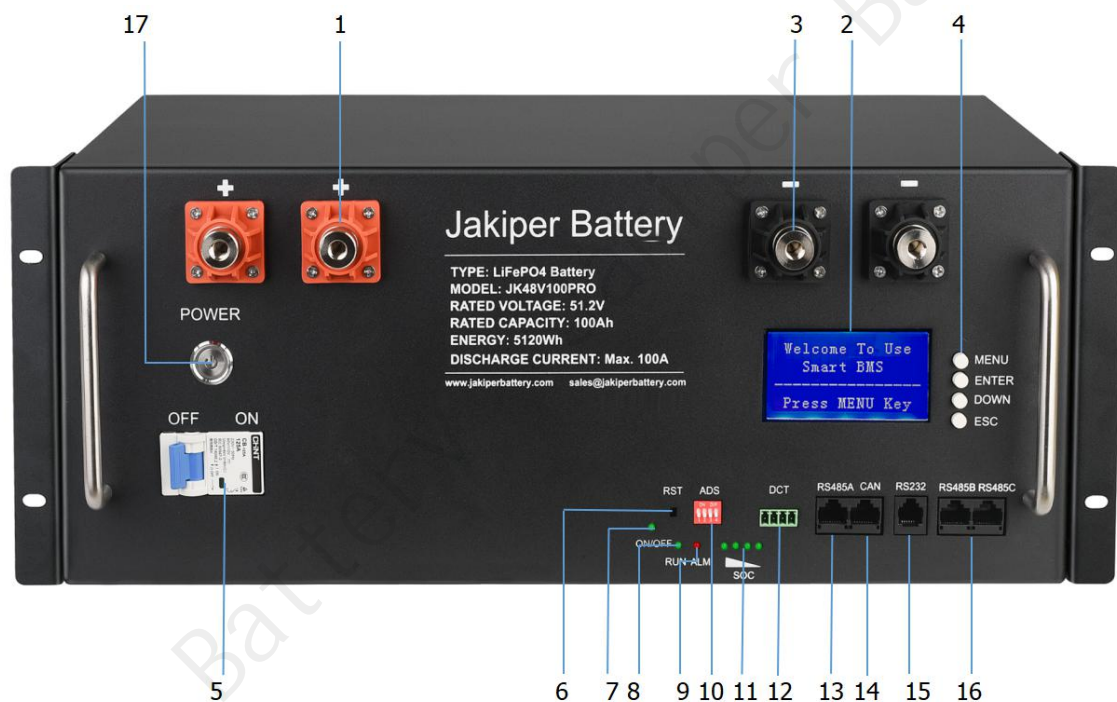

No.	Description	Functional Description
1	Battery +	Positive Terminal
2	LCD	Display Screen
3	Battery -	Negative Terminal
4	LCD Key	LCD Operated Button
5	MCB	Output ON/OFF
6	Reset key	On/OFF Button
7	ON/OFF LED	Battery ON/OFF Indicator LED
8	RUN	Battery Running Signal
9	ALM LED	Alarm Indicator Light Blinking
10	ADS	Battery Address Dip Switch
11	SOC	Battery Remain Capacity Indication
12	DCT	2 x Dry Contacts Output
13	RS485A connection port	RS485 Communication to Inverter
14	CAN connection port	CAN Communication to Inverter
15	RS232 connection port	RS232Communication to PC
16	RS485B & RS485C connection port	Battery Internal Communication Port
17	Power Key	On/Off BMS

2.4 General

2.4.1 Power & RST Key

Power Key	On/Off BMS
RST Key	In the non-standby state of BMS, press the key for 10S, until all LED light up for reset.

2.4.2 Breaker

Battery positive loop equipped with breaker, rated 125A, able to operate in DC system, designed for isolating positive while do wiring, also acting as secondary protection in addition to Smart BMS protection.

2.4.3 ADS (Address)

Dip switch settings for multiple batteries. While connecting to inverter the master battery address normally set as 1 (or ON OFF OFF OFF), and auxiliary packs set as per below table.

Address	DIP switch position				Note
	#1	#2	#3	#4	
0	ON	OFF	OFF	OFF	stand-alone use
1	ON	OFF	OFF	OFF	master Pack
2	OFF	ON	OFF	OFF	Auxiliary Pack1
3	ON	ON	OFF	OFF	Auxiliary Pack2
4	OFF	OFF	ON	OFF	Auxiliary Pack3
5	ON	OFF	ON	OFF	Auxiliary Pack4
6	OFF	ON	ON	OFF	Auxiliary Pack5
7	ON	ON	ON	OFF	Auxiliary Pack6
8	OFF	OFF	OFF	ON	Auxiliary Pack7
9	ON	OFF	OFF	ON	Auxiliary Pack8
10	OFF	ON	OFF	ON	Auxiliary Pack9
11	ON	ON	OFF	ON	Auxiliary Pack10
12	OFF	OFF	ON	ON	Auxiliary Pack11
13	ON	OFF	ON	ON	Auxiliary Pack12
14	OFF	ON	ON	ON	Auxiliary Pack13
15	ON	ON	ON	ON	Auxiliary Pack14

2.4.4 DCT(Dry Contacts)

Dry Contacts are mostly unused, but for communication with some non-smart systems please see the table below. Working current should be less than 2A, mainly to connect with an external indicator light or buzzer.

PIN1 to PIN2	Always open, will close with low battery signal
PIN3 to PIN4	Always Open, will close with fault/protection signal.



1 2 3 4

2.4.5 RS485A&CAN (RJ45 Connector)

RS485A and CAN ports are configured to connect with inverter. Some inverter communicate through RS485, and some of the inverter designed to communicate through CAN.

	BMS RS485A Port RJ45 Connector	BMS CAN Port RJ45 Connector
Pin No.	Definition	Definition
1	B	--
2	A	--
3	GND	--
4	--	CANH
5	--	CANL
6	--	--
7	--	--
8	--	--

2.4.6 RS232 (RJ12 Connector)

RS232 (RJ12 Connector) Port are used for programming and retrieving information via PC only and must be left open. The port and standard USB-RS232-RJ12 definition as below table.

Definition	RS232 Connector(9Pin)	RJ12 Port (6Pin)	Definition
PC Receive	Pin 2	Pin3	BMS Transmit
PC Transmit	Pin 3	Pin4	BMS Receive
GND	Pin 5	Pin2,5	GND
NC			NC

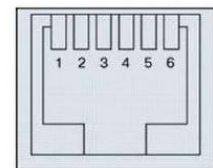

2.4.7 RS485B&RS485C (RJ45 Connector)

When installing more than one battery in parallel, a standard RJ45 patch network cable will be required for internal-battery communication. These cables will need to be connected to port RS485B or RS485C between all the connected batteries. The ports are paralleled therefore any port can be used for in or out connection.

2.4.8 Positive & Negative Terminal

Battery has 2 positive terminals, internal connected together. 2 negative terminals, internal connected together.

2.5 Buzzer Operation (Optional)

Model	Description and Status
Fault	Buzzing 0.25S per 1Sec
Protection	Buzzing 0.25S per 2Sec (expect for over-charge protection)
Alarm	Buzzing 0.25S per 3Sec (expect for over-charge alarm)

NOTE: Buzzer function can be set by monitor software, the default is off.

Note: Circuit breaker of battery circuit is set to OFF, connect it to switch power supply, and output voltage of switch power supply is set to (51.2V)56-58.4V, current set to 0.2C; after all settings done, switch the circuit breaker ON

2.6 LED Indicators

LED Indicators:

There are 6 LEDs on upper panel to show the battery working status:

Pack Status	Normal/Alarm/Protection	RUN	ALM	SOC Indication LED				Remark
		●	●	●	●	●	●	
Power Off	Sleep	OFF	OFF	OFF	OFF	OFF	OFF	All OFF
Standby	Normal	Flash 1	OFF	Indication By SOC				Standby
	Alarm	Flash 1	Flash 3					Battery Under Voltage
Charge	Normal	ON	OFF	Indication By SOC				-
	Alarm	ON	Flash 3					-
	Over Charge Protection	ON	OFF					-ALM LED is Off When Overcharge Protection
	Temperature/Over current protection	OFF	ON					Stop Charge
Discharge	Normal	Flash 3	OFF	Indication by SOC				-
	Alarm	Flash 3	Flash 3					-
	Over Discharge Protection	OFF	OFF					Stop Discharge
	Temperature/Over current/Short circuit protection	OFF	ON					Stop Discharge
Fault		OFF	ON	OFF	OFF	OFF	OFF	Stop Charge & Discharge

NOTE: LED function can be set by monitor software, the default is on.

Flash	ON	OFF
Flash1	0.25Sec	3.75Sec
Flash2	0.5Sec	0.5Sec
Flash3	0.5Sec	1.5Sec

2.7 Display Function Instruction

2.7.1 Display Rendering

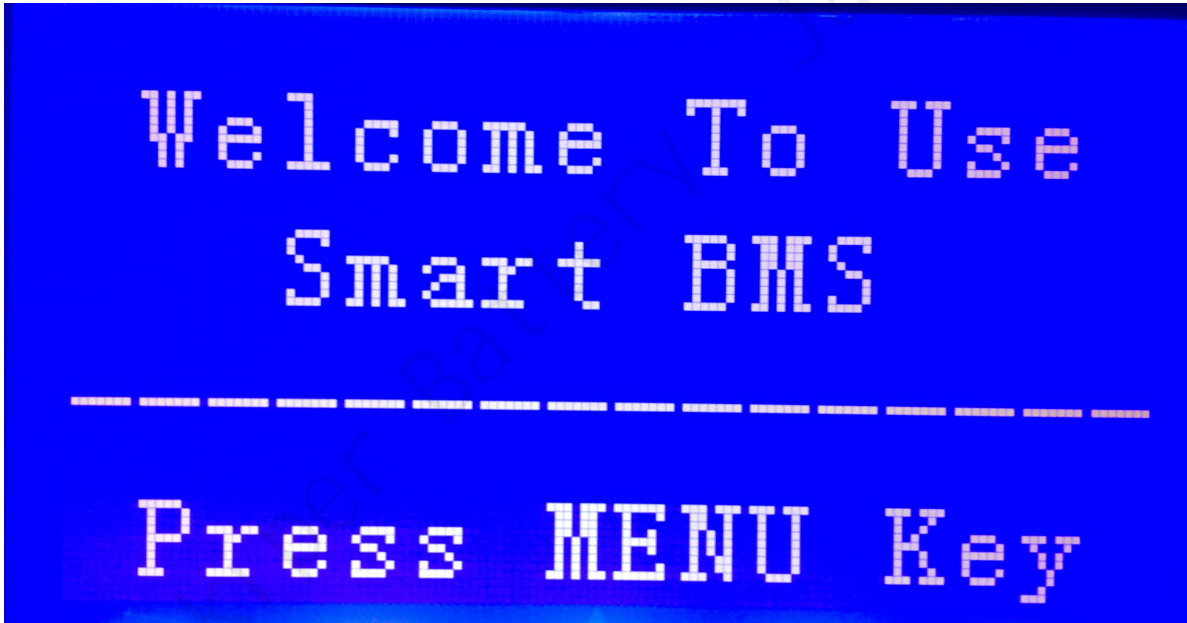

2.7.2 Functional Specifications

2.7.2.1 Main Menu Page

Electricity / dormancy activated, will show the welcome screen, press the MENU button to enter the main menu page. As shown in the figure below:

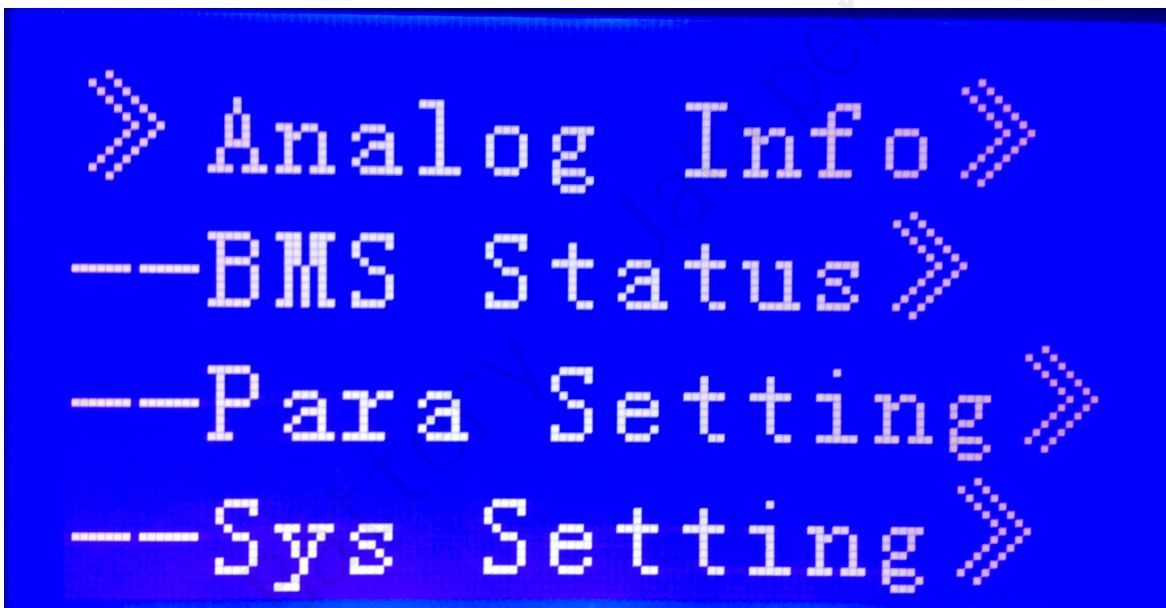

2.7.2.2 Battery Parameters Collection Page

When the cursor “»” is point to “Analog Info”,press ENTER key will enter into the page of “Analog Info”,As shown in the figure below:

<pre> » PackV: 52.44 V --Im: 0.00 A --Temperature» --Cell Voltage» </pre>	<pre> --T1: 31.2°C --T2: 31.0°C --T3: 32.1°C --T4: 31.0°C </pre>	<pre> --Cell01: 3277 mV --Cell02: 3278 mV --Cell03: 3278 mV --Cell04: 3277 mV </pre>
<pre> » CellCapacity» </pre>	<pre> SOC: 20.96 % FCC: 100.0AH Rm : 20.9AH CC : 0 </pre>	

2.7.2.3 Battery Status Page

When the cursor “»” is point to “BMS Status”,press ENTER key will enter into the page of “BMS Status”,As shown in the figure below:

<pre> » Status: Idle --Record» --BMS Status» </pre>	<pre> » SCP: 5 --O/UTP: 0 --OCP: 0 --UVP: 4 </pre>	<pre> » OVP: 1 </pre>
<pre> » OT : N --OTP: N --OV: N --OVP: N </pre>	<pre> » UV : N --UVP: N --OC: N --OCP: N </pre>	<pre> » SCP: N --Failure: N </pre>

2.7.2.4 Battery Parameters Setting Page

When the cursor “»” is point to “Para Setting” ,press ENTER key will enter into the page of “Para Setting” ,As shown in the figure below:

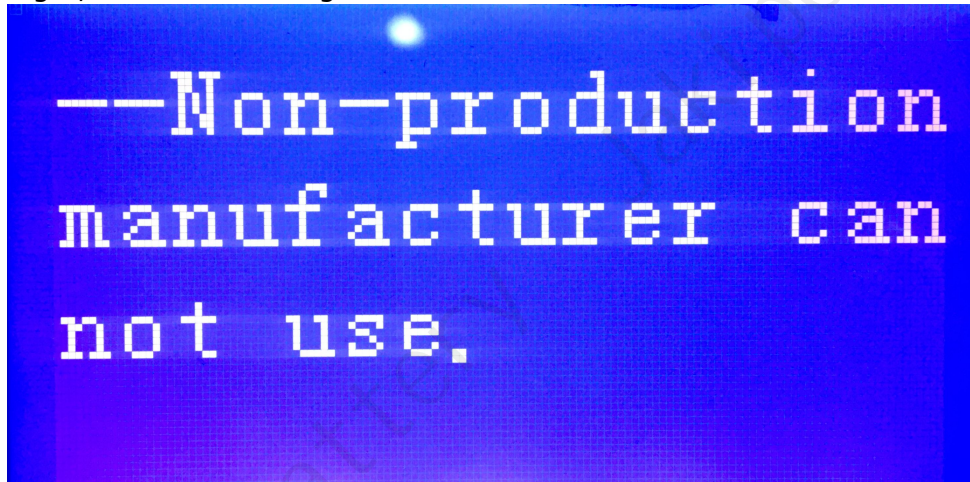

2.7.2.5 Battery System Setting Page

When the cursor “»” is point to “Sys setting” ,press ENTER key will enter into the page of “Sys setting” ,As shown in the figure below:

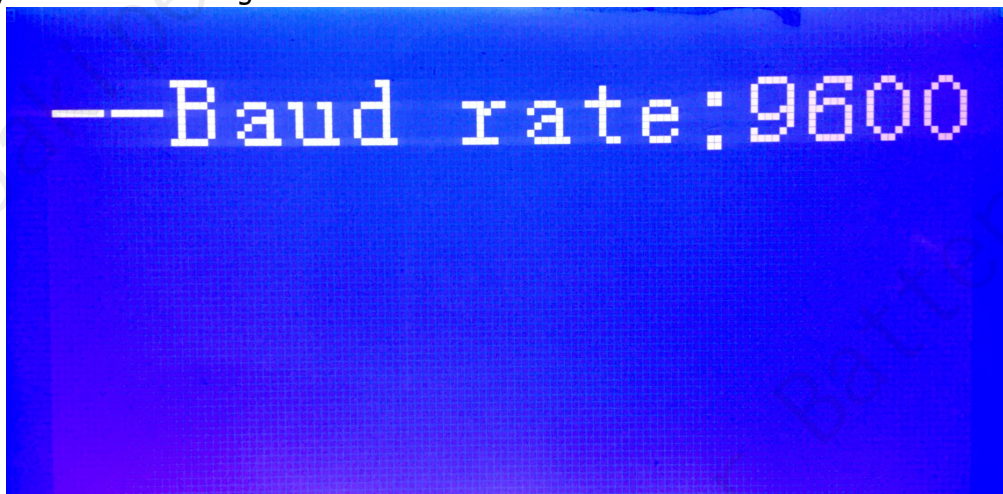

2.7.2.6 Key Description

- 1) SW1----NEMU,SW2----ENTER,SW3----DOWN, SW4----ESC.
- 2) Each item is “»” or “--” as a beginning,among them “»” shows the current cursor position,press UP or DOWN key can move the cursor position; with “»” end of the project,the content of the said project has not shown, press ENTER key can enter the corresponding page.
- 3) Press ESC key can be returned at the next higher level directory; In any position, press NEMU key can return to the main menu page.
- 4) In a dormant state, press any key, can activate the screen.

2.7.2.7 Dormancy/Shutdown

Under normal operation condition, with no keystrokes 1 minutes later, system will enter a state of dormancy/shutdown. Shutdown/dormancy state, press any key, screen can be activated.

3. Safe handling Guide

3.1 System Diagram

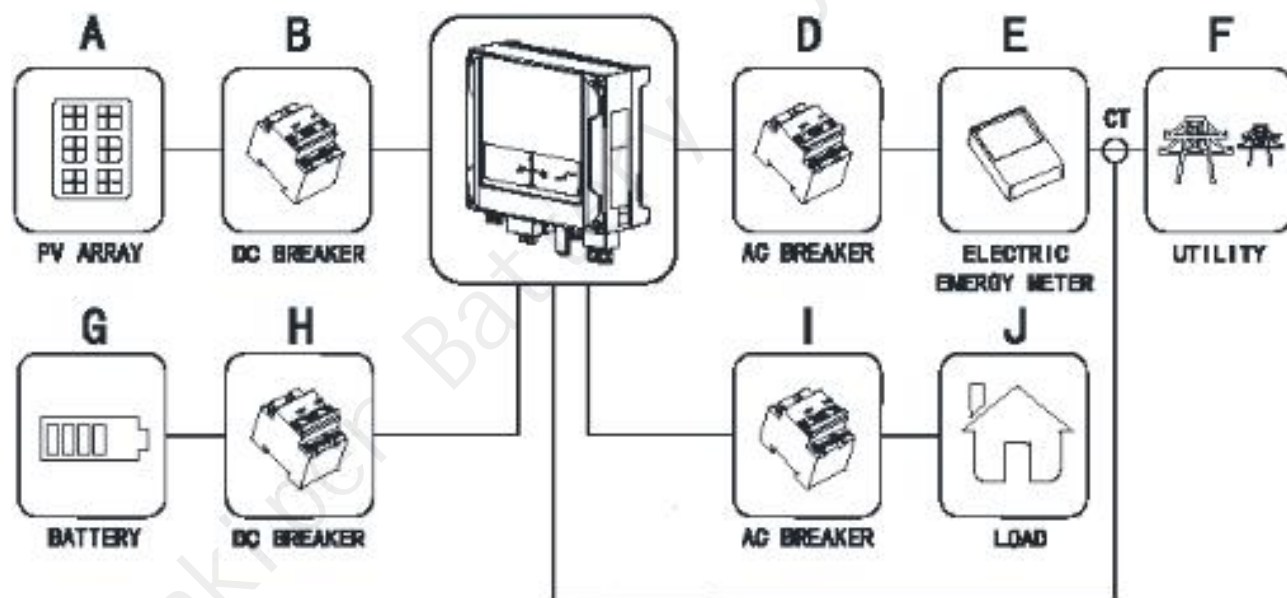

3.2 Tools

The following tools are required to install the battery pack:

- Cable Lugs
- Cut Plier
- Crimping Modular Plier
- Screw Driver

NOTE: Use properly insulated tools to prevent accidental electric shock or short circuits. If insulated tools are not available, cover the entire exposed metal surfaces of the available tools, except their tips, with electrical tape.

3.3 Safety Gear

It is recommended to wear the following safety gear when dealing with the battery pack:

- Insulated gloves
- Safety goggles
- Safety shoes

3.4 Installation

3.4.1 Standard Telecom Server Rack Cabinet Install

Thoroughly inspect the packaging upon receipt of goods. If there is any item that is missing or if there is any damage to the external packaging or to the unit itself upon unpacking, please contact the supplier immediately.

1. Choose suitable standard 19" telecom server rack cabinet.
2. Find side handler and screw in each battery package.
3. Fix side handler and screw on each battery pack.
4. Insert battery pack inside cabinet and complete the wiring.

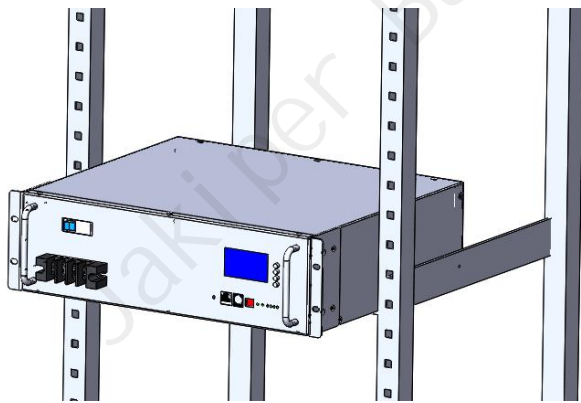

Standard 19"

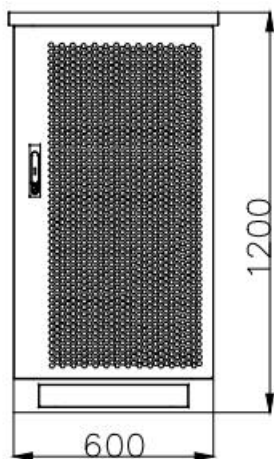

Front view

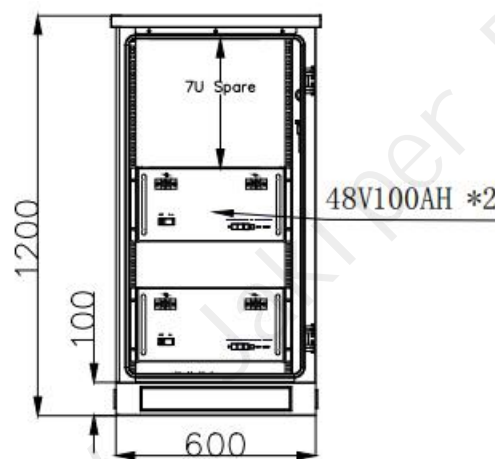

Hide door front view

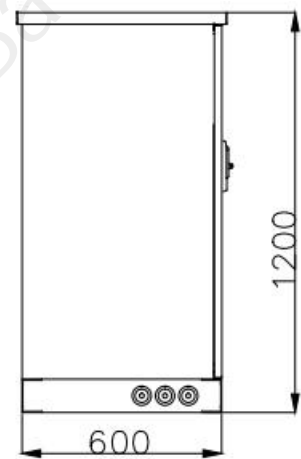

Side view

Example of 200Ah Cabinet Install

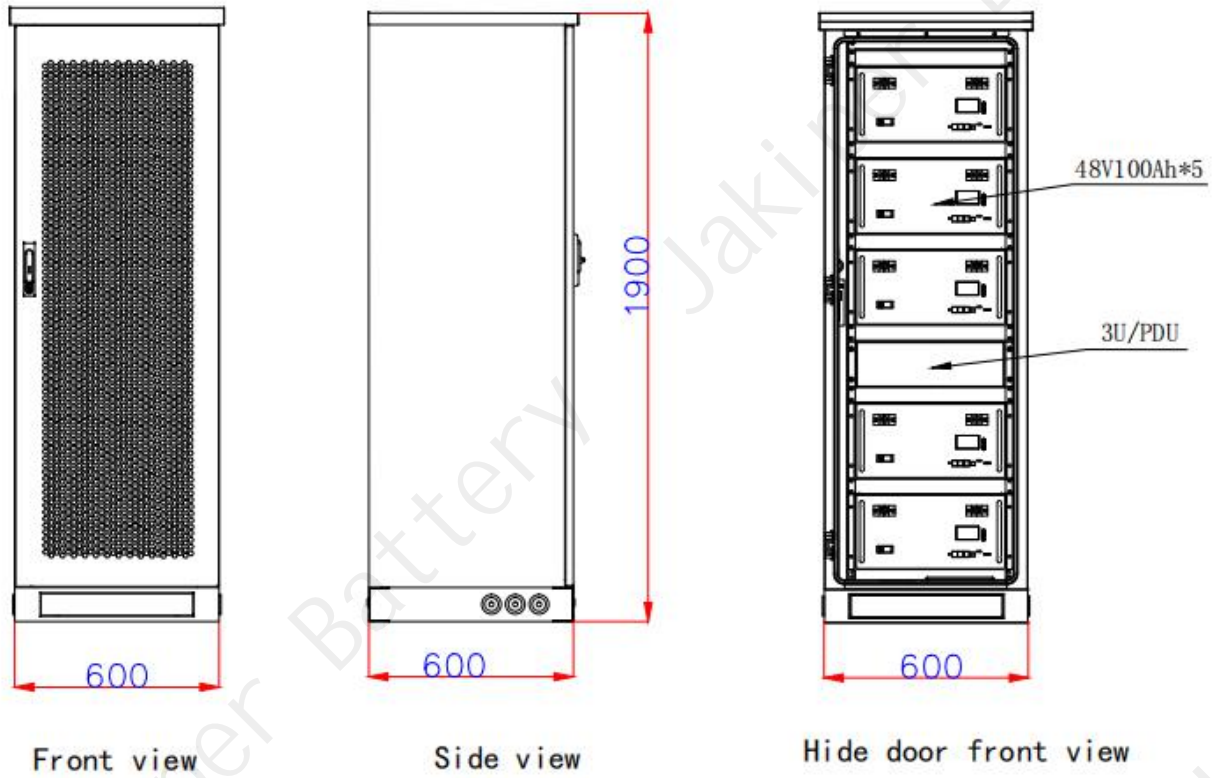

Example of 500Ah Cabinet Install

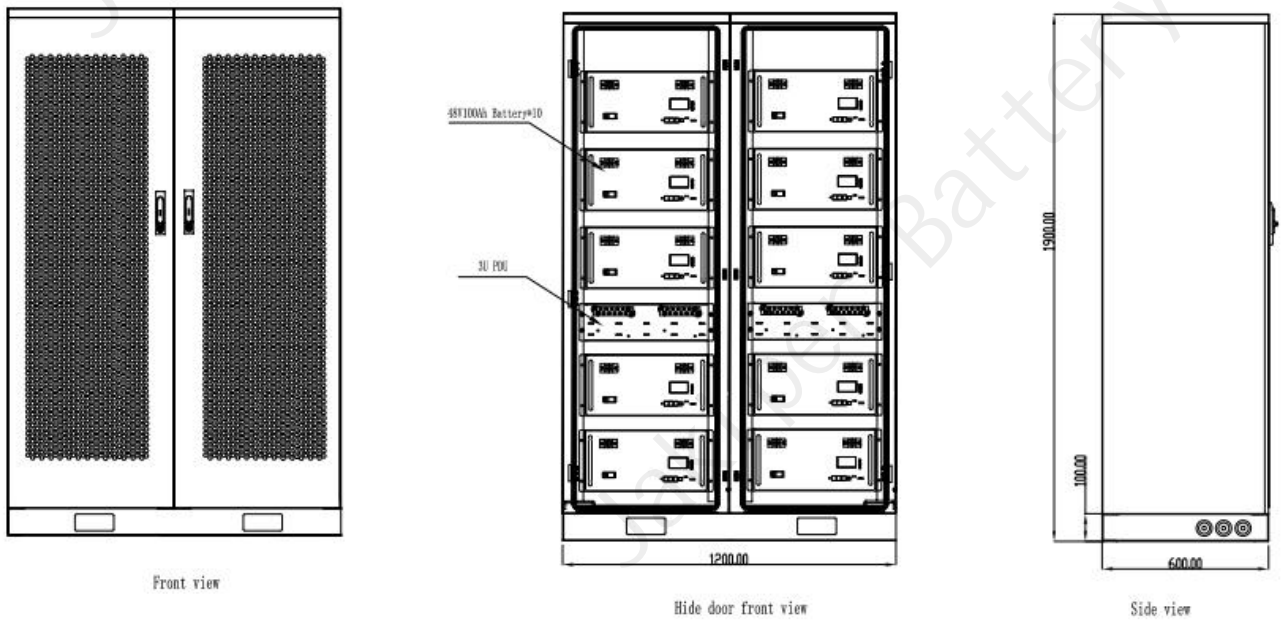

Example of 1000Ah Cabinet Install

3.4.2 Simple Self Rack Mounted

1. Choose suitable firm table or rack with height greater than 20mm (off the ground).
2. Place battery rack with LCD panel side face forward or upward.
3. Install side handler between each 2 packs with 6 screws each side.
4. Addition available fixture for fix backward of the pack is recommended.

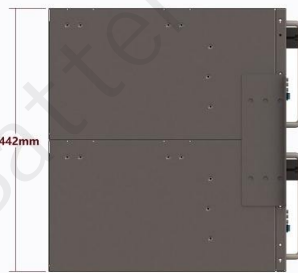

Example of 200Ah Simple Install



Example of 300Ah Simple Install

NOTE: For above simple installation, each stack no more than 3 packs, consider the weight of the battery.

3.4.3 Battery Parallel Connection

Make sure circuit breaker off before wiring:

- JK48V100 Battery designed for unlimited parallel.

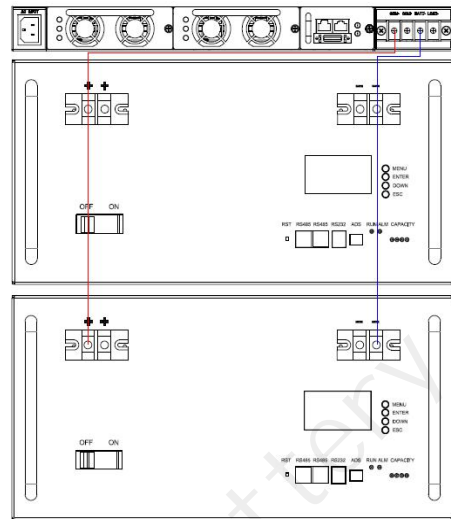
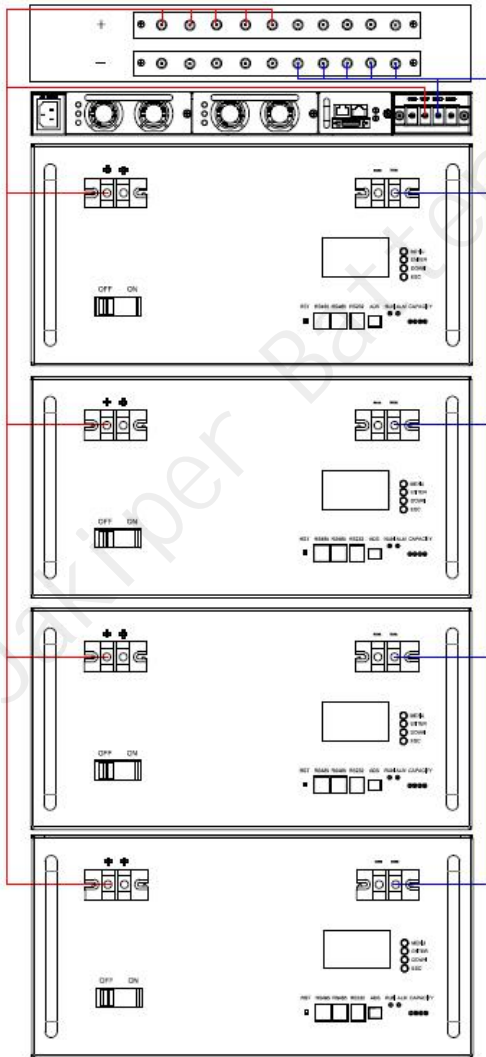

Example of 500Ah and 200Ah Battery Parallel Connection

Note: Do not serial connect battery pack.

3.4.4 Other Wire Connection

Make sure that all the wires connected, then turn on circuit breaker:

- Connect to charger:

Circuit breaker of battery circuit is set to OFF, connect it to charging supply, and output voltage of charge power supply is set to 56-58.4V (16S LiFePO4 Battery Option).

- Connect to inverter:

Circuit breaker of battery circuit is set to OFF, connect it to inverter, and inverter input voltage is set to 44.8-58.4V (16S LiFePO4 Battery Option).

- After all settings done, switch the circuit breaker ON.

3.4.5 Installation Location

Make sure that the installation location meets the following conditions:

- The installation site must be suitable for the size and weight of the battery.
- Must be installed on a firm surface to sustain the weight of battery.
- The area is water proof.
- There are no flammable or explosive materials in proximity.
- The ambient temperature is within the range from 0°C to 45°C.
- The temperature and humidity is maintained at a constant level.
- There is minimal dust and dirt in the area.
- Installation must be vertical or tilted backwards by maximum 15° - avoid forward or sideways tilt.

4. Software & Communication

4.1 USB-RS232-RJ12 Driver Installation

To use USB-RS232-RJ12 connect PC and use PC software, a driver should be installed.

Follow steps as below(or check in Jakiper Website Blog):

- ❖ Download driver from product download tag.
- ❖ Un-Zip Files.
- ❖ Plug in USB-RS232-RJ12 to PC.
- ❖ PC>Device Manager>Find ? mark device>Right click>update driver>update driver from unzipped files folder.
- ❖ Refresh PC>Device Manager to Verify

4.2 PC Software Installation

To use USB-RS232-RJ12 connect PC and use PC software, a BMS APP should be installed on PC.

Follow steps as below(or check in Jakiper Website Blog):

- ❖ Download software V2.50 from product download tag.
- ❖ Un-Zip Files.
- ❖ Open software.
- ❖ Plug in RS232 wire.
- ❖ Open communication port.
- ❖ Start Monitoring.

4.3 BMS & Inverter Communication Setup

4.3.2 Communicate With PC/Software

4.3.2.1 Single Battery Communicate with PC/Software

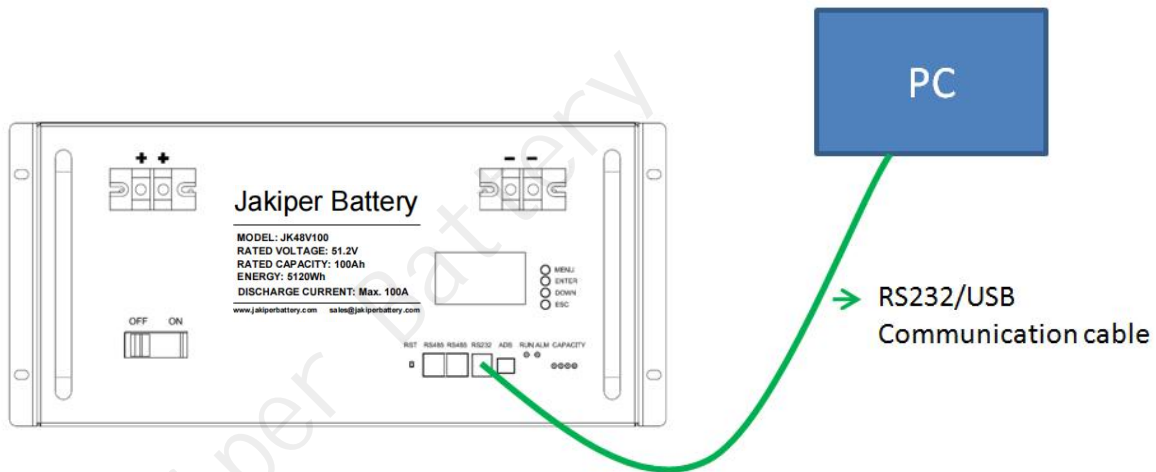

4.3.2.2 Batteries Parallel Communicate with PC/Software

While battery in parallel communication, dial-up addresses of battery are different.

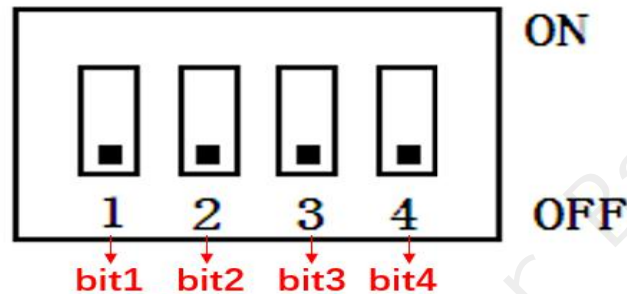

Address	Dial Switch				Remark
	bit1	bit2	bit3	bit4	
1	ON	OFF	OFF	OFF	Battery 1
2	OFF	ON	OFF	OFF	Battery 2
3	ON	ON	OFF	OFF	Battery 3
4	OFF	OFF	ON	OFF	Battery 4
5	ON	OFF	ON	OFF	Battery 5
.....
14	OFF	ON	ON	ON	Battery 14
15	ON	ON	ON	ON	Battery 15

Note: The range of batteries' address bit1-bit4 is 1-15.

Battery internal communication use standard internet cable connect though RS485B & RS485C ports.

For example:15 sets batteries in parallel communicated with PC/software as below:

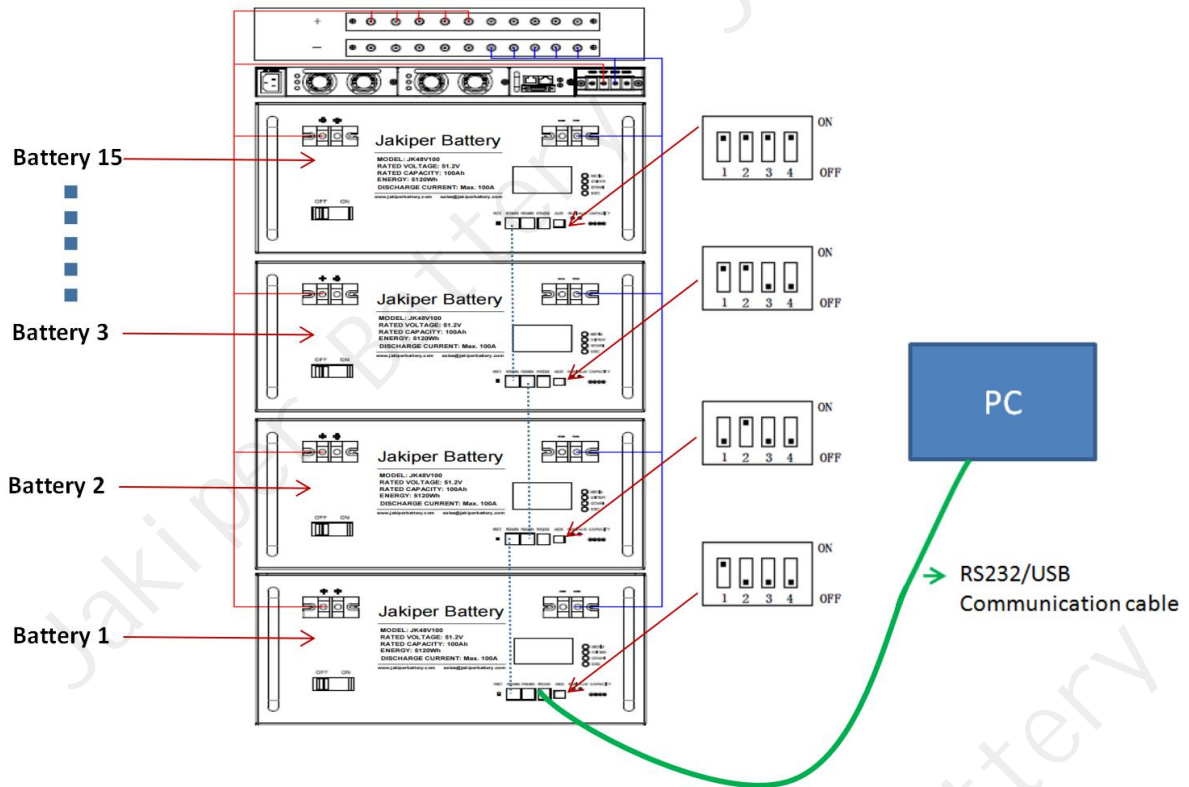

4.3.3 Communicate With Inverter (Optional)

Step 1: Communication Protocol Select

- ❖ BMS pre-loaded with many brand inverter protocol, select the correct protocol as per brand & model of the inverter been used.
- ❖ Different model inverters from same brand/company may use different protocol, detailed setting please check Jakiper latest published videos.

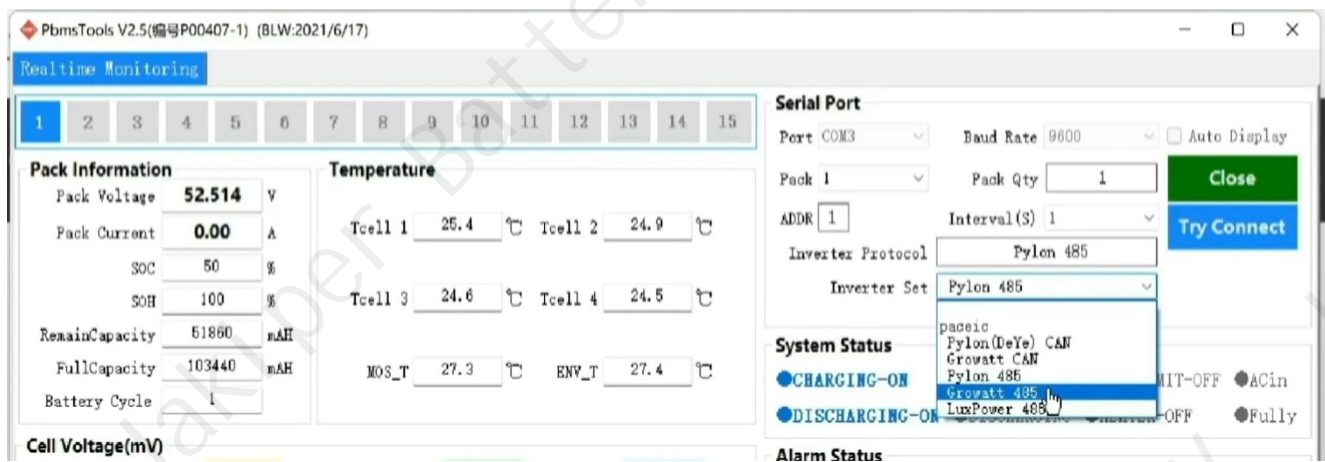

Step 2: Connect BMS & Inverter Communication Cable

- ❖ If communicated with MPP/LUX inverter, please connected with RS485 port of battery.
- ❖ If communicated with GROWATT/DEYE/VICTRON inverter, please connected with CAN port of battery.

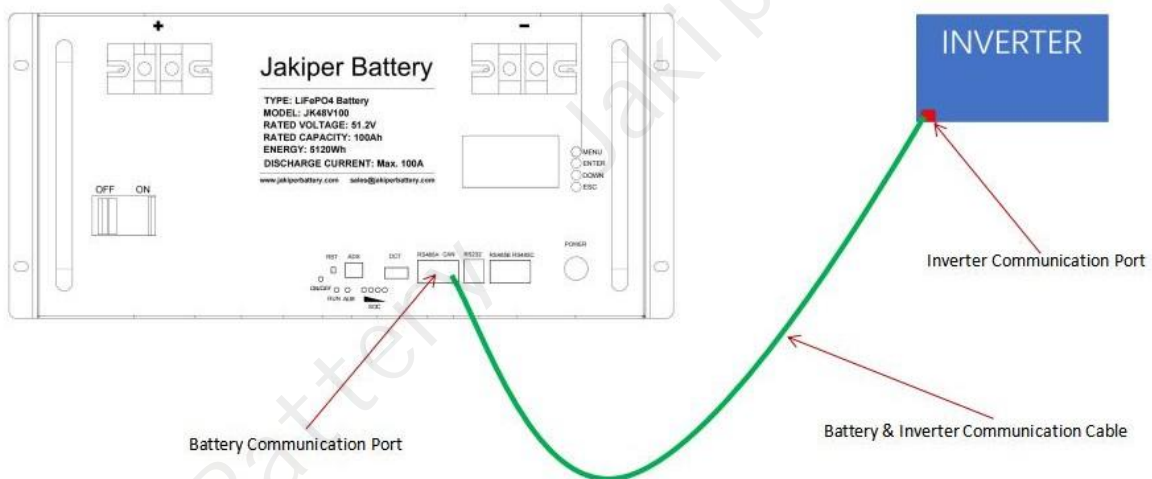

Step 3: ADS Setting

- ❖ The master battery ADS address set to 1 (or ON OFF OFF OFF), slave batteries set as per 4.3.2.2

Step 4: Inverter Setting

- ❖ Inverter battery type select as 'Li'
- ❖ Inverter battery communication protocol select as per inverter manual and refer to Jakiper latest published videos.

5. Troubleshooting

If the battery does not operate correctly, please solve the problem by using the table below.

Symptom	Possible cause	Remedy
All reading 0, and all temperature sensors -40	Anti-Theft Protected	Contact Tech support
RST Key no response press 0-10s	RST Key Damage	Contact Tech support
No indication and alarm in the front display panel	Sleeping mode	Press Reset to normal mode
No indication and alarm in the front display panel even Reset still no	Battery voltage too low	Charge battery immediately
Red LED Flashing when Standby	Battery cell low voltage	Charge battery immediately
Red LED Flashing when charging	Alarm for protection when charging	BMS show alarm, protect and adjustment
Red LED Flashing when Discharging	Battery too low and will shutdown	Charge battery immediately
RED LED Lighting continuous	Battery wrong	Need to repair

6. Storage and Maintenance

6.1. Storage

Before storing, charge the battery at least 7 hours. Store the Battery covered and upright in a cool, dry location. Recommend long-term storage temperature is 15°C -25°C . During storage, recharge the battery in accordance with the following table:

Storage Temperature	Recharge Frequency	Charging Duration
0°C - 40°C	Every 3 months	1-2 hours

6.2. Maintenance



The battery system operates with hazardous voltages. Repairs may be carried out only by qualified maintenance personnel.



Even after the unit is disconnected from the mains, components inside are still connected to the battery cells which are potentially dangerous.



Before carrying out any kind of service and/or maintenance, disconnect the batteries and verify that no current is present and no hazardous voltage exists in the terminals.



Only persons are adequately familiar with batteries and with the required precautionary measures may replace batteries and supervise operations. Unauthorized persons must be kept well away from the batteries.



Verify that no voltage between the battery terminals and the ground is present before maintenance or repair. In this product, the battery circuit is not isolated from the input voltage. Hazardous voltages may occur between the battery terminals and the ground.



Batteries may cause electric shock and have a high short-circuit current. Please remove all wristwatches, rings and other metal personal objects before maintenance or repair, and only use tools with insulated grips and handles for maintaining or repairing.



When replace the batteries, install the same number and same type of batteries.



When replace the parallel batteries, make sure the new battery is full charged.



Do not open or destroy batteries. Escaping electrolyte can cause injury to the skin and eyes. It may be toxic.

7 Product Responsibilities and Consulting

- 1) We will not be liable for the accidents resulting from operation breaking this specification and user manual.
- 2) We will not send separate notice, provided that the contents of this specification are changed due to improvement of product quality or technological upgrading; provided that you want to understand the latest information of this product, please contact us.
- 3) The shelf life of this product is within 24 months after it is delivered; we will maintain the product, which is in the warranty period for free of charge, provided that it has any product quality problems within the specified operation range; we may replace the relevant parts, if we fail to maintain it, so as to achieve the purpose of sustainable use without performance reduction; our after-sales service personnel will propose the specific maintenance and troubleshooting methods.
- 4) In case of any questions, please contact us
 - For getting fast reply, you could join in our facebook group:
<https://www.facebook.com/groups/jakiperbattery>
Post your questions in this Facebook group.
 - Or if you don' t have a facebook account, please drop us an email to:
sales@jakiperbattery.com
If no reply in 24 hours, you could check the spam folder or send an reminder.

